

# SNEAKERSER+

KNOWLEDGE BEHIND EVERY PRODUCT



LOOK BOOK/  
PRODUCT GUIDE

**CONTENTS/  
LOOK BOOK  
AND PRODUCT GUIDE**

ABOUT/.....1  
 CLEAN & PROTECT/ .....4-30  
 CUSTOMISE/.....31-45  
 ACCESSORIES/.....46-50  
 COLLABORATIONS / PARTNERSHIPS/...51-68  
 PRODUCT INDEX/.....71-75

“The most versatile,  
extensive range in  
today's sneaker market.”





## ABOUT/ SNEAKERS ER

**Founded in 2015 by two friends and sneaker enthusiasts, Alan Lynn and Robert Stewart, from Glasgow, SNEAKERS ER was established to bring the best quality sneaker care products to market.**

Alan & Robert have long established relationships with sneakers dating back to the early Crooked Tongues forum and beyond.

Both own sneaker collections of several hundred pairs (and growing), perfect for meticulously testing new product ideas on!

Our range is researched, designed and developed with the sole purpose of keeping your sneakers at their optimum best.

We source premium materials both locally (when possible) and responsibly, never compromising on quality.

SNEAKERS ER strive to be the best, resulting in a full and comprehensive range that our loyal customers know and love today.



## CLEANER/ PREMIUM SNEAKER CLEANING SOLUTION

**The go to cleaner for sneaker heads and professionals alike.**

Our marshmallow scented Premium Sneaker Cleaning Solution comes in a 250ml bottle which can clean up to 100 pairs. Safely cleans suede, leather, mesh, nubuck, canvas, knitted uppers and more. Our solution has outstanding results cleaning denim bleed, grease and oil.

Packaged in easy to display cardboard packaging.

**Minimum order: 12 units.**

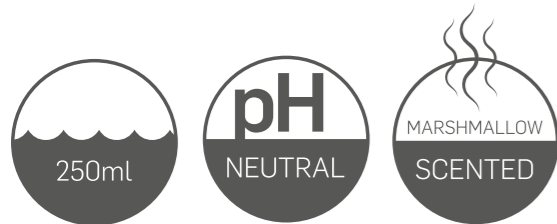

- 250ml for up to 100 cleans
- Marshmallow scented
- pH Neutral solution
- Removes most denim bleed
- Safe on all materials including suede and delicates



## CLEANER/ PREMIUM SNEAKER CLEANING BRUSH

**The safest brush for all materials, including delicates.**

FSC approved natural wood from 100% well managed forests and natural fibres from the Mexican Agave lechuguilla plant.

This soft to medium bristle fibre has great liquid holding and release properties which absorb 65% more water than artificial plastic fibres.

Our brush keeps it's qualities and smoothness over time.

Packaged in easy to display cardboard packaging with bristle touch window cut out.

**Minimum order: 6 units.**

- FSC approved wood
- Natural plant fibres
- Safe on all materials including suede and delicates



**MICROFIBER/  
PREMIUM SNEAKER  
CLEANING CLOTH**

**A luxury microfibre cloth that is safe on all materials.**

Our high quality microfibre cloth with high water absorption rate is the ideal addition to your sneaker cleaning routine, absorbs water and solution foam effectively during the cleaning process. The microfibrils work with a capillary action that draws dirt in to the cloth.

Great for on the spot cleaning with neat solution and fully machine washable.

Packaged in easy to display cardboard packaging with cloth touch window cut out.

**Minimum order: 6 units.**

- Quality microfibre
- High water absorption rate
- Great for on the spot cleaning
- Fully machine washable

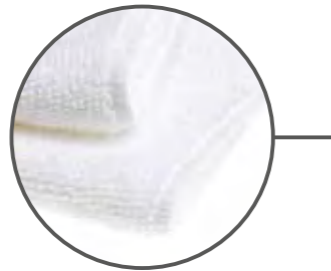

Embroidered Patch



**REVIVER/  
PREMIUM CREPE  
RUBBER SUEDE BRUSH**

**Bring your suede back to life after cleaning with our amazing rubber brush.**

FSC approved natural wood from 100% well managed forests. Made from crepe rubber, this brush is the absolute best and safest way to revive suede by bringing back the nap after cleaning sneakers. The crepe rubber also loosens dirt while absorbing stains, also works well on nubuck.

Packaged in easy to display cardboard packaging with touch window cut out.

**Minimum order: 6 units.**

- FSC approved wood
- Crepe rubber that's safe on suede and nubuck
- Gently cleans and buffs fibres thoroughly
- Ergonomic design for comfortable use



**CLEANER/  
PREMIUM SNEAKER  
CLEANING KIT**

**250ml Premium Sneaker Cleaner**

The go to cleaner for sneaker heads and professionals alike.

Marshmallow scented Premium Sneaker Cleaning Solution. 250ml bottle which can clean up to 100 pairs. Safely cleans suede, leather, mesh, nubuck, canvas, knitted uppers and more, our solution has outstanding results cleaning denim bleed, grease and oil.

**Premium Sneaker Cleaning Brush**

The safest brush for all materials, including delicates.

FSC approved natural wood from 100% well managed forests and natural fibres from the Mexican Agave lechuguilla plant.

This soft to medium bristle fibre has great liquid holding and release properties which absorb 65% more water than artificial plastic fibres.

Our brush keeps it's qualities and smoothness over time.

Packaged in easy to display cardboard packaging with bristle touch window cut out.

**Minimum order: 24 units.**



2 piece kit

- 250ml for up to 100 cleans
- Marshmallow scented
- pH Neutral solution
- Removes most denim bleed
- FSC approved wood
- Natural plant fibres
- Safe on all materials including suede and delicates



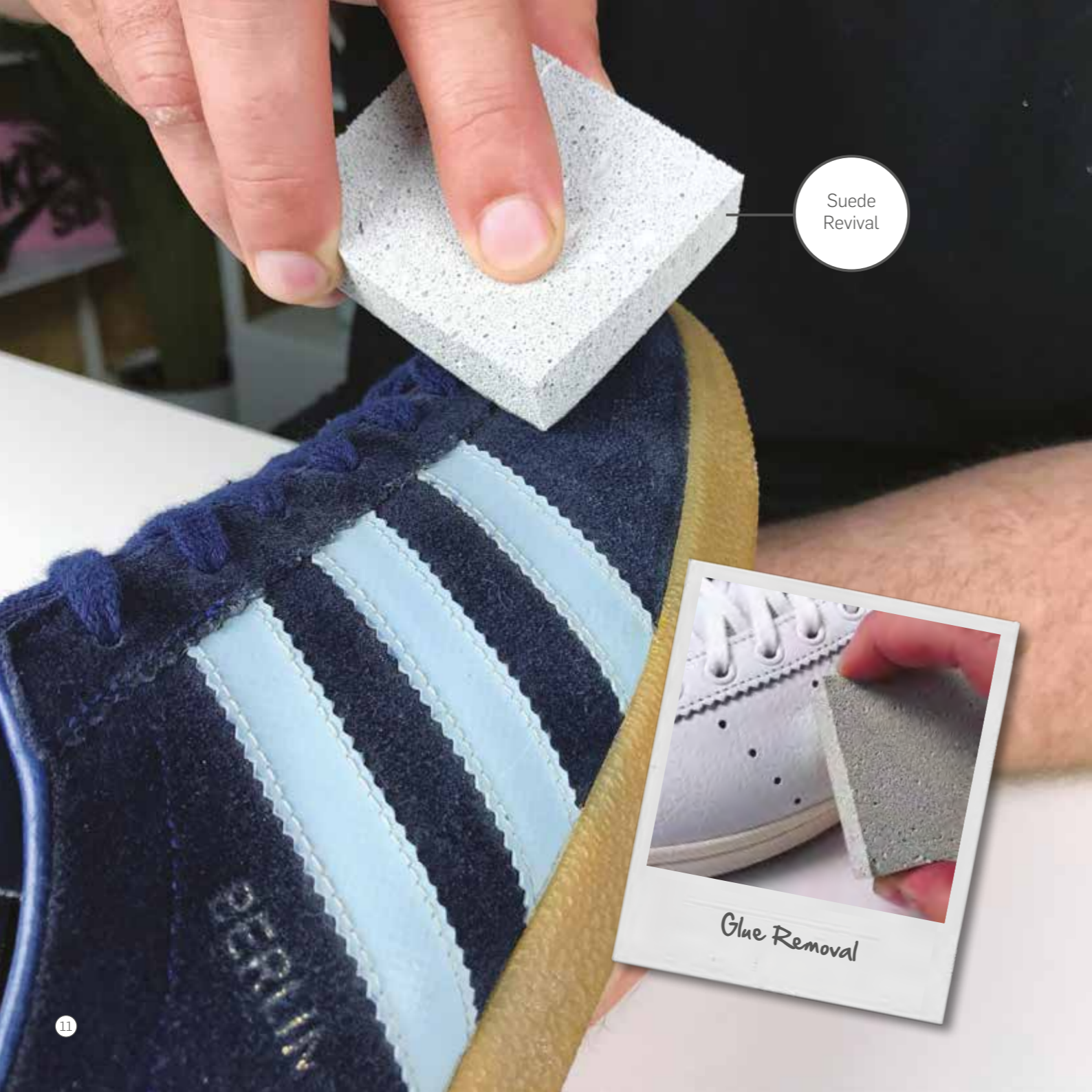

Suede Revival



## ERASER/ NATURAL RUBBER SUEDE AND NUBUCK SNEAKER BLOCK

**The ultimate spot cleaning block for suede and nubuck.**

Made with 100% natural caoutchouc rubber which safely cleans scuffs, our 65mm block also removes stains & revives nap.

Two sided block for easy use, the crepe side is great for on the spot cleans and removing scuffs, the synthetic side is fantastic for roughing up the suede fibres.

Packaged in easy to display cardboard packaging with touch window cut out.

**Minimum order: 6 units.**

- 100% natural caoutchouc rubber
- 65mm square block
- Removes scuffs
- Roughens up suede



**PROTECTOR/  
LONG-LASTING  
SUPERHYDROPHOBIC  
SNEAKER PROTECTOR**

Market leading eco-friendly, non-toxic formula that is suitable for all materials including, suede, leather, mesh, nubuck, canvas, knitted uppers and much more.

Resistant to all liquids, it forms a solvent free, highly durable, long-lasting, invisible and protective barrier against water, coffee, oil spillages and other accidental stains.

When applied, SNEAKERS ER Superhydrophobic Protector encases each textile fibre with an invisible coating of silicon dioxide at nanometre level (one millionth of a millimetre). These nano sized structures bond to each fibre ensuring long-lasting protection.

**Minimum order: 24 units.**



- Long-lasting protection
- Resistant to all liquids
- Forms a protective invisible layer
- Safe on suede and delicates

**NEW**  
250ml



**PROTECTOR/  
SUPERHYDROPHOBIC  
SNEAKER APPLICATOR BRUSH**

15cm FSC Approved Natural wood handle from 100% well managed forests.

100% horsehair brush that is perfect for the application of our SNEAKERS ER Superhydrophobic Protector.

The soft horsehair will not scratch leathers or other delicate materials like mesh, while gentle enough to work into suede nap.

**Minimum order: 12 units.**

- 100% horsehair
- FSC approved wood
- Safe on delicate materials



## PROTECTOR/ PREMIUM SNEAKER PROTECTION KIT

### 75ml Superhydrophobic Protector

Market leading eco-friendly, non-toxic formula that is suitable for all materials including, suede, leather, mesh, nubuck, canvas, knitted uppers and much more.

Resistant to all liquids, it forms a solvent free, highly durable, long-lasting, invisible and protective barrier against water, coffee, oil spillages and other accidental stains.

### Superhydrophobic Applicator Brush

100% horsehair brush that is perfect for the application of our SNEAKERS ER Superhydrophobic Protector.

The soft horsehair will not scratch leathers or other delicate materials like mesh, while gentle enough to work into suede nap.

**Minimum order: 12 units.**

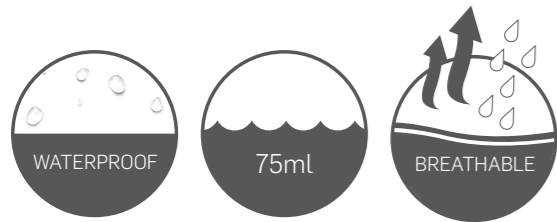

2 piece kit

- Long-lasting protection
- Resistant to all liquids
- Forms a protective invisible layer
- Safe on suede and delicates
- 100% horsehair
- FSC approved wood
- Safe on delicate materials





## PROTECTOR/ FAST ACTION ALL-ROUND SNEAKER PROTECTOR

**SNEAKERS ER Fast Action All-Round Nano Technology Protector provides innovative and fast protection from water/fluids, stains and dirt penetration.**

Our ultra-performance nano technology formula is suitable for use on suede, leather, mesh, nubuck, canvas, knitted uppers and much more.

SNEAKERS ER Fast Action All-Round Sneaker Protector gives an all-round fully breathable protective barrier for your sneakers, while delicate materials such as suede and nubuck remain soft and supple.

**Minimum order: 24 units.**



- All round sneaker protector
- Innovative nano-technology
- Fast action



**NOURISHER/  
PREMIUM SNEAKER  
LEATHER REVIVING CREAM**

**A luxurious soft cream for polishing and preserving leather.**

NOURISHER revives colour and preserves leather, ideal for luxury brand sneakers.

Applied with a soft, lint-free cotton cloth, our NOURISHER brings tired leather back to life.

Fresh spring fragrance.

**Minimum order: 6 units.**

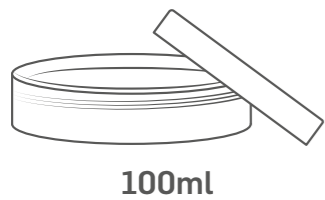

- Luxury leather cream
- Revives
- Polishes
- Preserves
- Colourless



**CONDITIONER/  
PREMIUM SNEAKER  
WATERPROOF DUBBIN WAX**

**A luxurious soft wax for the waterproofing, nourishing and reconditioning of dried, waxed and oily leather.**

Suitable for leather sneakers including lifestyle, designer or sports.

Applied with a soft, lint-free cotton cloth, our CONDITIONER breathes new life into tired sneakers

Contains almond oil.

**Minimum order: 6 units.**

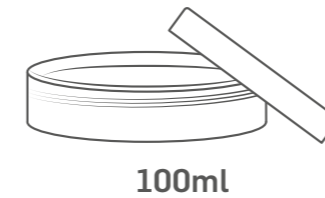

- Luxury leather wax
- Nourishes
- Conditions
- Waterproofs
- Colourless



## TRAVELER/ SNEAKER CLEANING KIT

### 100ml Premium Sneaker Cleaner x 3

Safely cleans suede, leather, mesh, nubuck, canvas, knitted uppers and more, our solution has outstanding results cleaning denim bleed, grease and oil.

### Premium Sneaker Cleaning Brush

The safest brush for all materials, including delicates. Great liquid holding and release properties which absorb 65% more water than artificial plastic fibres.

### Premium Sneaker Cleaning Cloth

A luxury microfibre cloth that is safe on all materials. Great for on the spot cleaning with neat solution and fully machine washable.

**Minimum order: 3 units.**

Complete  
6 piece kit

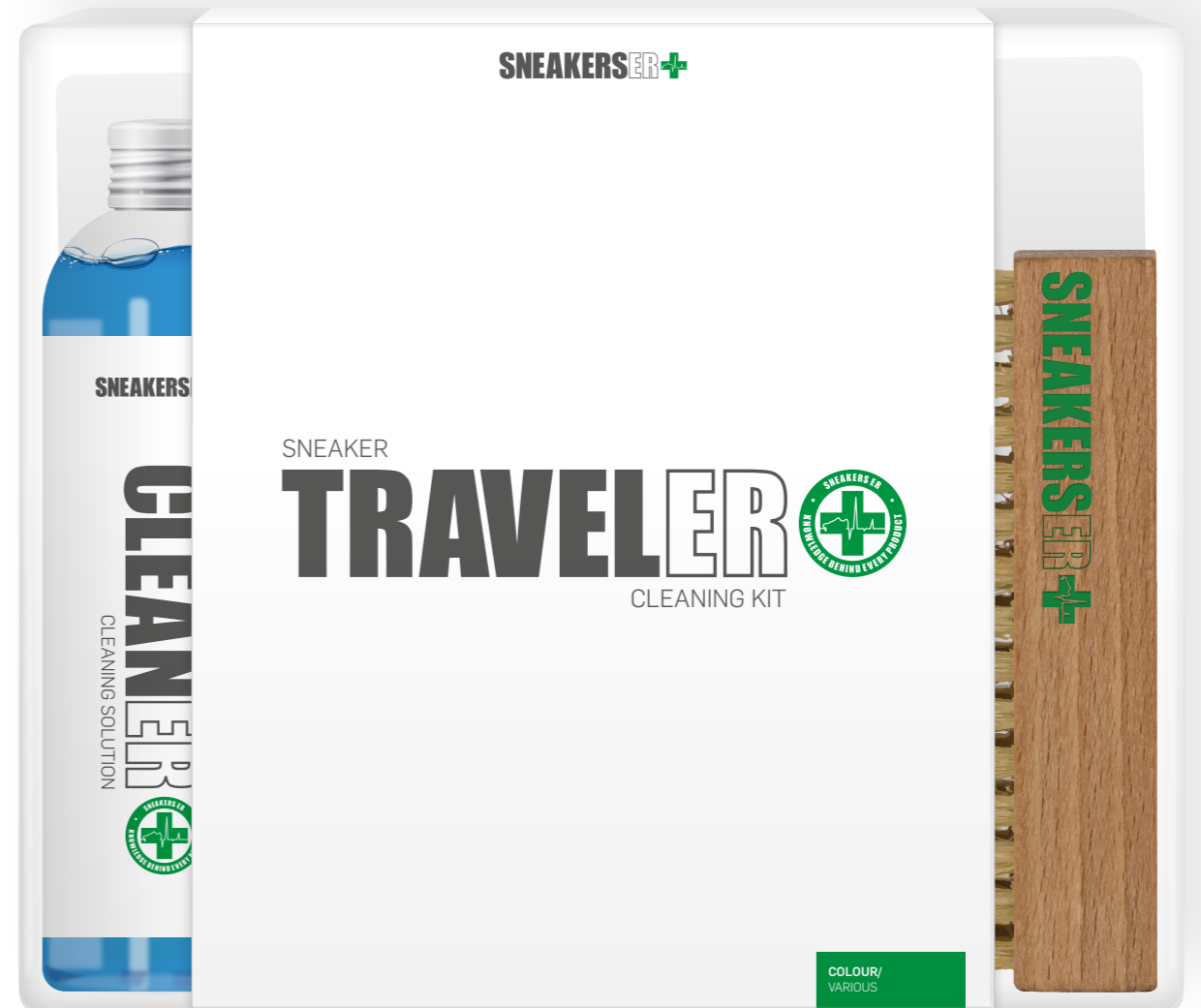

## DOPPER/ LUXURY SNEAKER LEATHER DOPP KIT

### 200ml Premium Sneaker Cleaner

Safely cleans suede, leather, mesh, nubuck, canvas, knitted uppers and more, our solution has outstanding results cleaning denim bleed, grease and oil.

### Premium Sneaker Cleaning Brush

The safest brush for all materials, including delicates. Great liquid holding and release properties which absorb 65% more water than artificial plastic fibres.

### Premium Sneaker Cleaning Cloth

A luxury microfibre cloth that is safe on all materials. Great for on the spot cleaning with neat solution and fully machine washable.

### 75ml Superhydrophobic Protector

Market leading eco-friendly, non-toxic formula that is suitable for all materials including, suede, leather, mesh, nubuck, canvas, knitted uppers and much more.

### Superhydrophobic Applicator Brush

100% horsehair brush that is perfect for the application of our SNEAKERS ER Superhydrophobic Protector.

### Premium Crepe Rubber Suede Brush

Made from crepe rubber, this brush is the absolute best and safest way to revive suede by bringing back the nap after cleaning sneakers.

**Minimum order: 3 units.**



“ Sneaker cleaning kit with soft 100% calf leather dopp bag. ”



## CLEAN & PROTECT/ SNEAKER KIT

### 200ml Premium Sneaker Cleaner

Safely cleans suede, leather, mesh, nubuck, canvas, knitted uppers and more, our solution has outstanding results cleaning denim bleed, grease and oil.

### Premium Sneaker Cleaning Brush

The safest brush for all materials, including delicates. Great liquid holding and release properties which absorb 65% more water than artificial plastic fibres.

### Premium Sneaker Cleaning Cloth

A luxury microfibre cloth that is safe on all materials. Great for on the spot cleaning with neat solution and fully machine washable.

### 75ml Superhydrophobic Protector

Market leading eco-friendly, non-toxic formula that is suitable for all materials including, suede, leather, mesh, nubuck, canvas, knitted uppers and much more.

### Superhydrophobic Applicator Brush

100% horsehair brush that is perfect for the application of our SNEAKERS ER Superhydrophobic Protector.

**Minimum order: 6 units.**

Complete  
5 piece kit

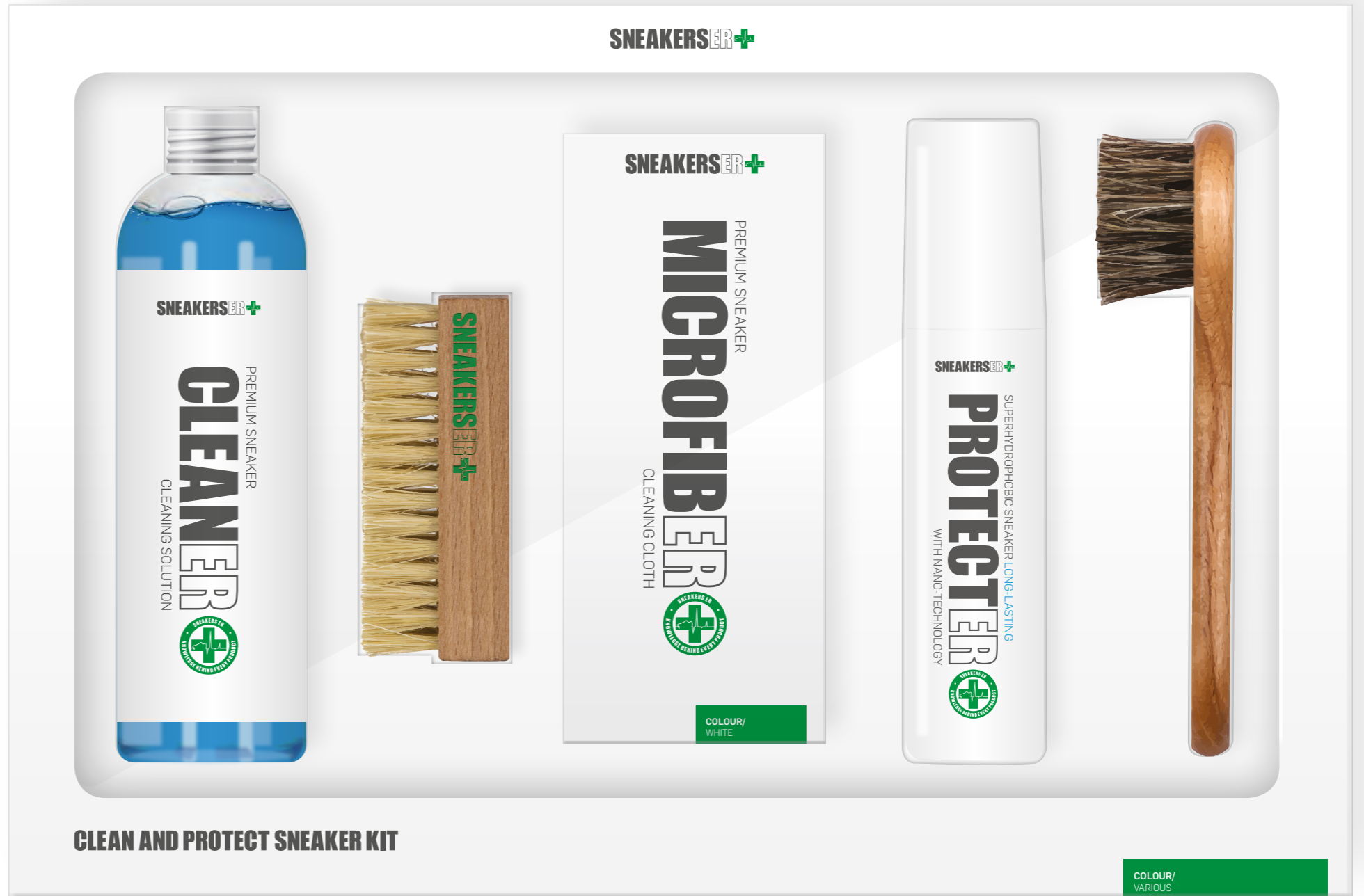

## CLEAN AND PROTECT SNEAKER KIT

## CLEAN & PROTECT/ SUEDE AND LEATHER SNEAKER CARE KIT

### 75ml Superhydrophobic Protector x 2

Market leading eco-friendly, non-toxic formula that is suitable for all materials including, suede, leather, mesh, nubuck, canvas, knitted uppers and much more.

### Superhydrophobic Applicator Brush

100% horsehair brush that is perfect for the application of our SNEAKERS ER Superhydrophobic Protector.

### Natural Rubber Suede and Nubuck Sneaker Block

Made with 100% natural caoutchouc rubber which safely cleans scuffs, our 65mm block also removes stains & revives nap.

### Premium Crepe Rubber Suede Brush

Made from crepe rubber, this brush is the absolute best and safest way to revive suede by bringing back the nap after cleaning sneakers, the crepe rubber also loosens dirt while absorbing stains, also works well on nubuck.

**Minimum order: 6 units.**

Complete  
5 piece kit

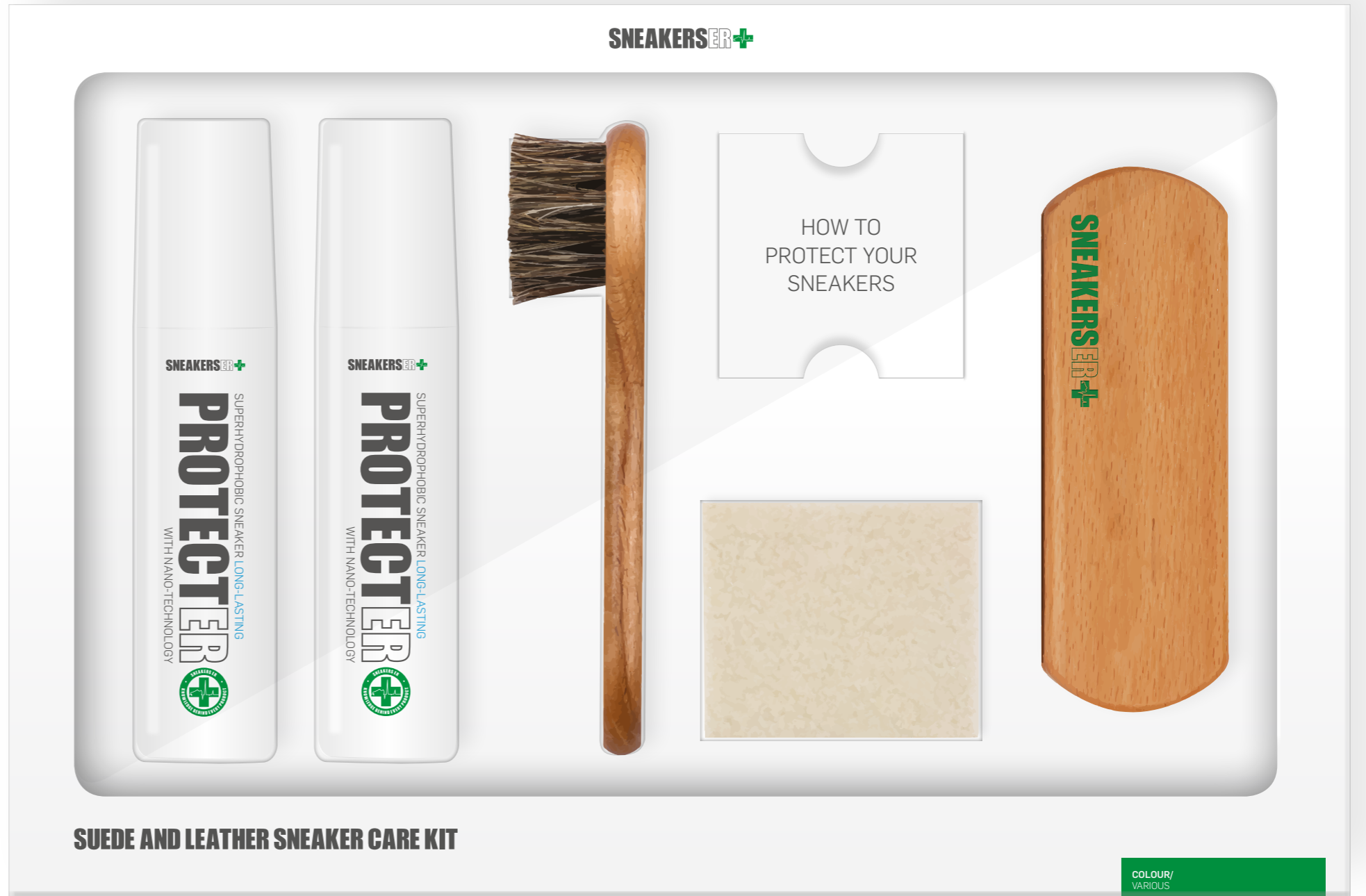

## DEODORISER/ PREMIUM NEUTRALISING SNEAKER DEODORANT

Keep your sneakers fresh and hygienic with our Premium Neutralising Sneaker Deodorant.

Available in three fantastic scents:

- Bergamot & Cedarwood
- Mediterranean Lemon
- Orange & Sandalwood

Minimum order: 12 units.

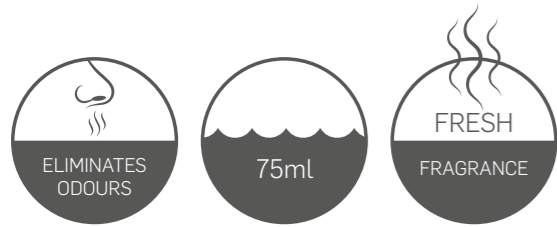

- Direct refreshing effect
- Absorbs unpleasant odour molecules
- Neutralises odour molecules
- Long-lasting effect
- Provides fibres with an invisible protective layer



## BERGAMOT & CEDARWOOD



**Bergamot (*Citrus uranum* var. *bergamia*):** is a small, roughly shaped citrus fruit which grows on small trees known as bergamots. Named after the Italian city of Bergamo, the essential oil of bergamot is expressed from the ripe fruit peel which gives a sweet fresh aroma.

**Cedarwood (*Cedrus*):** is a genus of conifers trees in the plant family Pinaceae, a native of the Himalaya mountains and Mediterranean region. Giving off a distinct woody, spicy scent.

## MEDITERRANEAN LEMON

**Mediterranean Lemon (*Citrus lemon*):** is a bright yellow fruit from a small thorny tree which originates from the Middle East before being brought to Spain, most likely a hybrid of Lime and Citron, with a sweet undertone and aromatic scent.



**Orange (*Citrus sinensis*):** is a citrus fruit which is a hybrid of Pomelo and Mandarin. From an evergreen flowery tree that is the most common tree fruit grown. Provides a sweet citrus scent.

**Sandalwood (*Santalum Album*):** is obtained from the trees of the genus *Santalum*, heavy in colour it retains its oriental, woody fragrance for a long time.





**CUSTOMISE/  
PREMIUM MIDSOLE  
PAINT MARKER**

**The original and best premium midsole paint marker.**

10mm chisel tip with special optimised valve system pump action for optimum flow control.

Good for many pairs depending on coverage and shoe size.

**Minimum order: 3 units (per colour).**

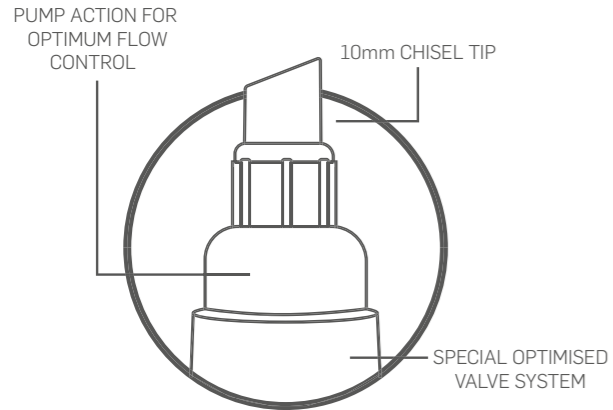

White	Black	Grey	Off-White
Gum	Red	Azure Blue	Desert Sand
Lavender	Military Green	Pastel Blue	Pastel Pink
Pastel Yellow	Pebble Grey	Salmon	Yellow
Burgundy	Dark Grey	Navy	Taupe
Infrared	Laser Blue	Cement Grey	Infrared OG
Varsity	Royal	Fire Red	Tiffany
Yeezy Mint	Volt	Turtle Dove	Pirate Black
Moonrock	Oxford Tan		

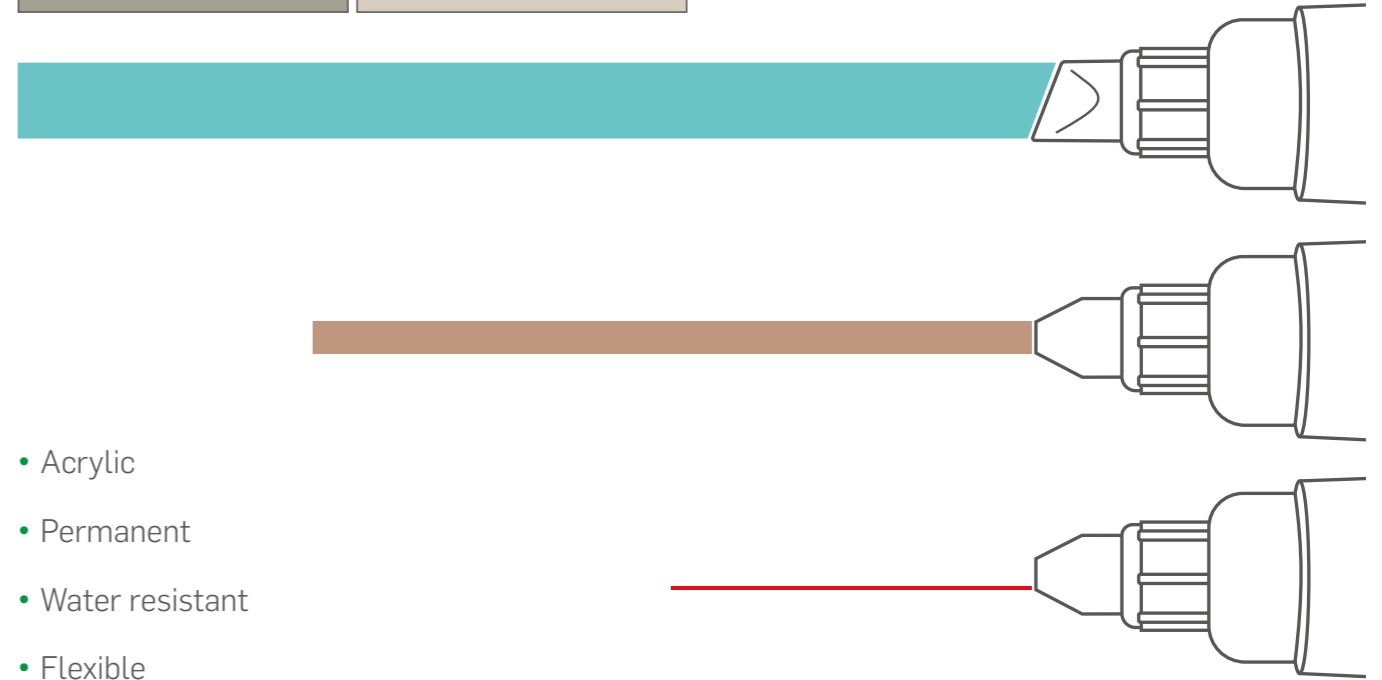



**FLIGHT COLLECTION/  
PREMIUM MIDSOLE  
PAINT MARKER TRIPLE PACKS**

The original and best premium midsole paint marker is now available in six 'Flight Collection' triple packs.

10mm chisel tip with special optimised valve system pump action for optimum flow control.

Good for many pairs depending on coverage and shoe size.

**Minimum order:** Single units.

White	White	White
Cement Grey	Fire Red	Infrared OG
Black	Black	Black
White	White	White
Infrared	Royal	Varsity
Black	Black	Black

- Acrylic
- Permanent
- Water resistant
- Flexible



## CUSTOMISE/ PREMIUM SNEAKER MIDSOLE PAINT

The original and best premium midsole paint is now available in 125ml bottles.

Good for many pairs depending on coverage and shoe size.

**Minimum order:** 3 units (per colour).

White

Black

Off-White

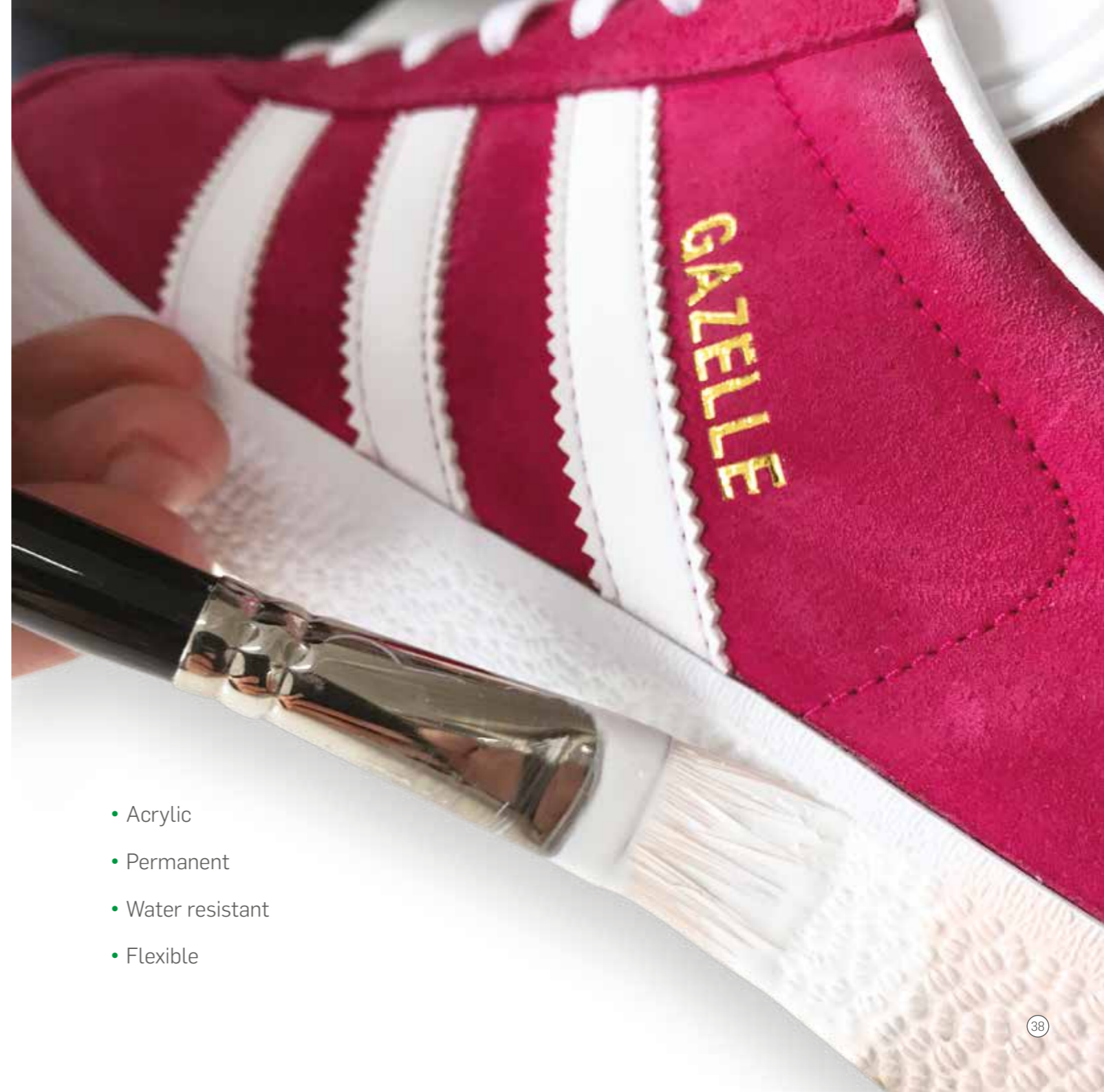

- Acrylic
- Permanent
- Water resistant
- Flexible

**CUSTOMISE/  
ACRYLIC LEATHER  
AND VINYL PAINT PEN**

The original and best acrylic leather paint pen.

2mm bullet tip acrylic leather paint pen with special optimised valve system.

Pump action for optimum flow control which allows accurate handling and application.

**Minimum order: 3 units (per colour).**

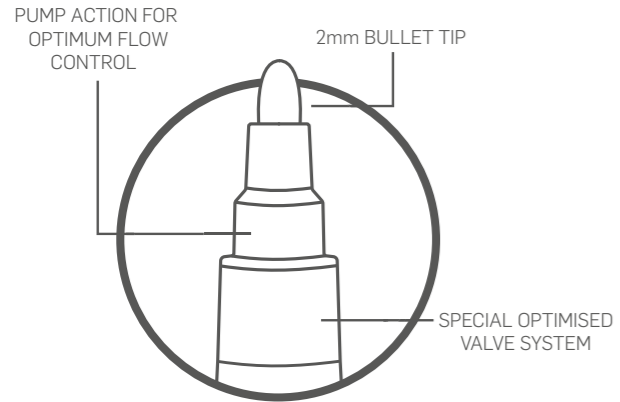

White	Black	Blue	Grey
Green	Light Blue	Light Green	Light Grey
Orange	Pink	Purple	Red
Turquoise	Yellow		



## DEGLAZER/ PREMIUM SNEAKER PAINT PREPARATION

For the preparation of leather prior to painting with our acrylic paint pens and midsole pens.

Ideal for stripping paint and factory finishes from leather sneakers prior to painting, DEGLAZER is also perfect for use on midsoles prior to using SNEAKERS ER Premium Midsole Paint Markers.

DEGLAZER is also good for the removal of stubborn stains or marks from leather sneakers.

Available in 125ml and 250ml screw top bottles.

**Minimum order: 12 units.**

- Removes factory finish
- Ideal for grime removal
- Perfect for sneaker customisation



## SOLE BONDER/ PREMIUM SNEAKER RESTORATION AND TRANSPLANT GLUE

Premium sneaker restoration and transplant glue.

The go to glue for professional customisers and amateurs alike, our glue is fast becoming a market leader in sole transplants, due to both it's flexible and strong properties.

Available in 125ml and 250ml screw top pots.

For general repairs and sole transplants.

**Minimum order: 6 units.**

- Flexible
- Strong
- Fast action





**ANGELUS FOR SNEAKERS ER/  
TERRACE COLLECTION  
SUEDE DYE**

Liquid Suede Dye which will colour, restore, and dress all nappy and suede leathers.

Available in 17 exclusive, specially matched, colours (plus colourless for mixing) for SNEAKERS ER Terrace Collection in collaboration with Angelus Brand USA.

**Minimum order: 6 units.**

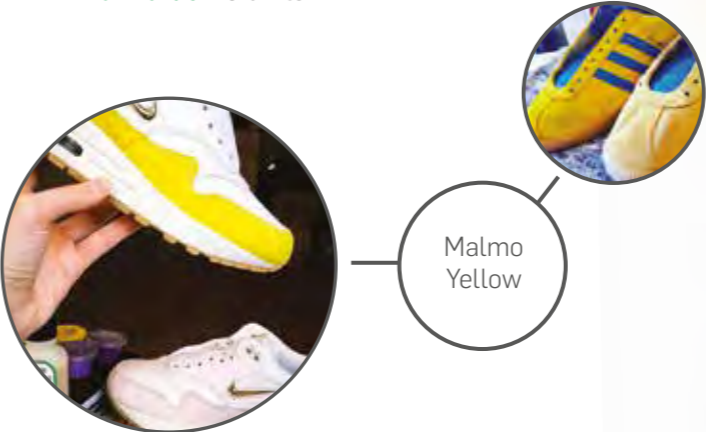

Malmo Yellow

- 17 specially matched colours
- Brilliant vibrant colours
- 3FL. OZ. / 88.7ml
- Box converts to no spill bottle stand
- Comes with real wool applicator





**SNEAKERSER+**

SUEDE SNEAKER DYE COLOUR CHART  
FOR NUBUCK, SUEDE AND NAPPY LEATHERS

# ACCESSORIES

## ODER FRESH/ SOCKLESS SNEAKER INSOLES

For those that wear sneakers without socks.

SNEAKERS ER ODER FRESH insoles are made from bioactive terry cloth which absorb sweat and moisture, thus helping to avoid and neutralise malodours.

The base of the insole is produced from Sisal, a natural fibre from the agave cactus that allows the feet to breathe while providing soft cushioning for extra comfort.

When frequently worn and washed the insole does not lose its antibacterial properties and keeps your feet fresh and hygienic.

Minimum order: 3 units per size.

- Bioactive terry cloth
- Breathable natural fibre
- Kills bacteria
- Long-lasting hygiene
- Absorbent
- Machine washable

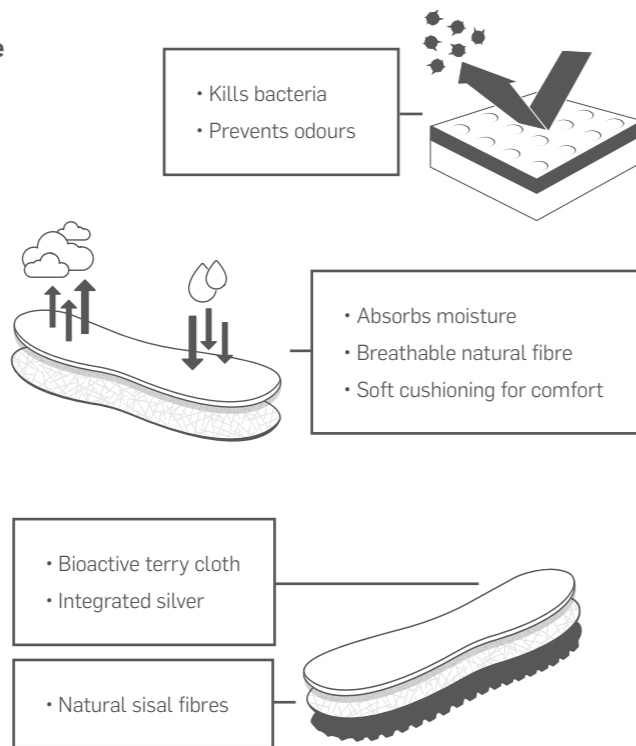

## ACCESSORIES/ PREMIUM SNEAKER LACES

High grade, proper OG vintage style cotton laces.

120cm long, 6mm thick premium laces made in Europe and available in a range of 10 colours.

Ideal replacements for OG Tobacco, adidas City series, vintage suedes, Nike Air Max and New Balance runners.

**Minimum order: 3 units.**

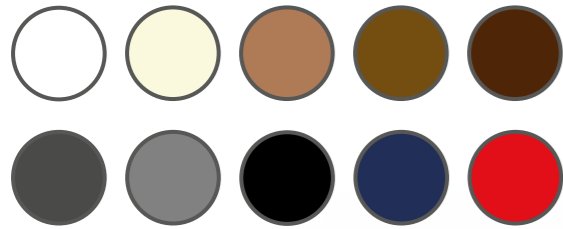

- 120cm length
- 6mm thick
- Vibrant colours
- European made

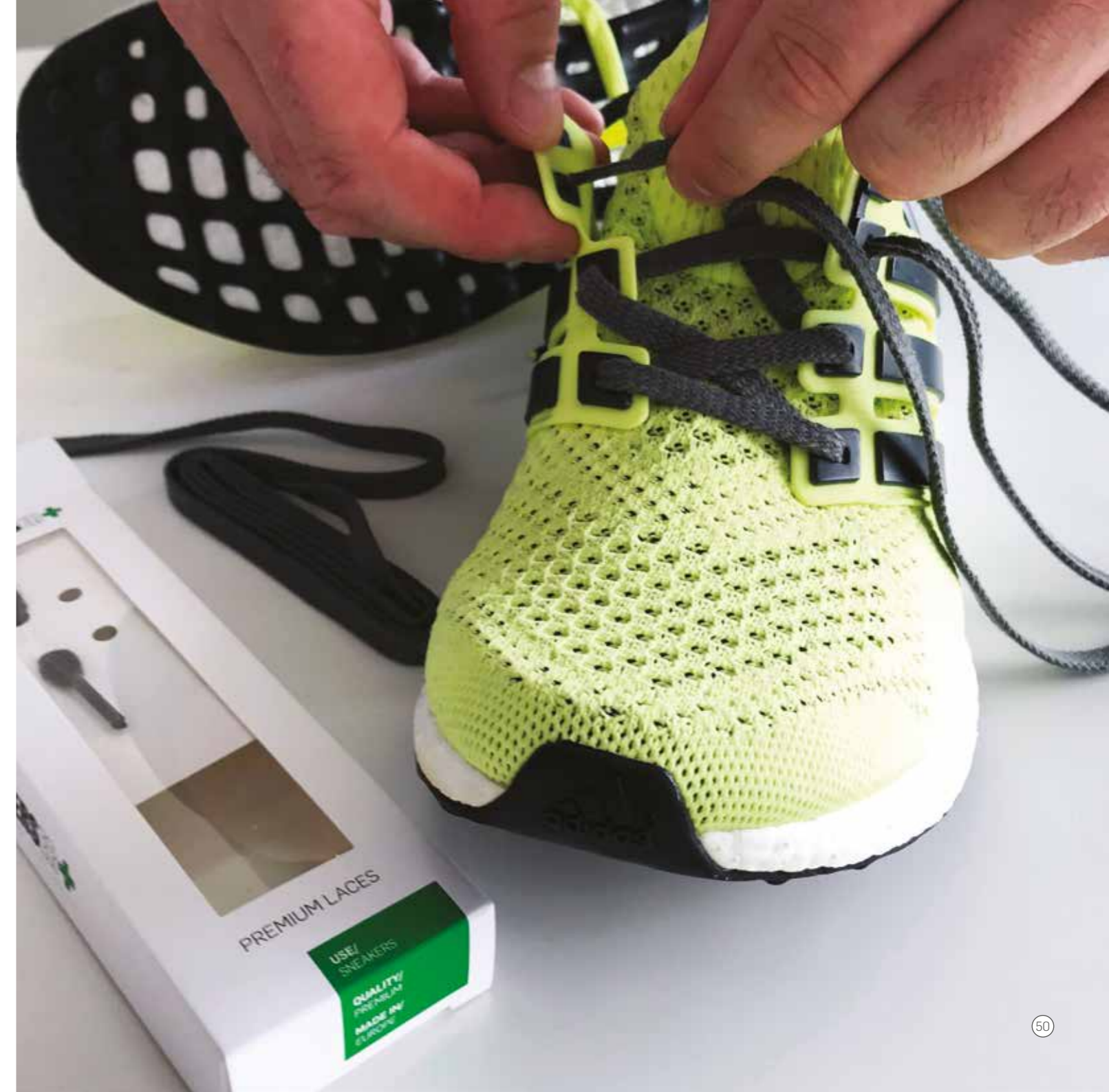
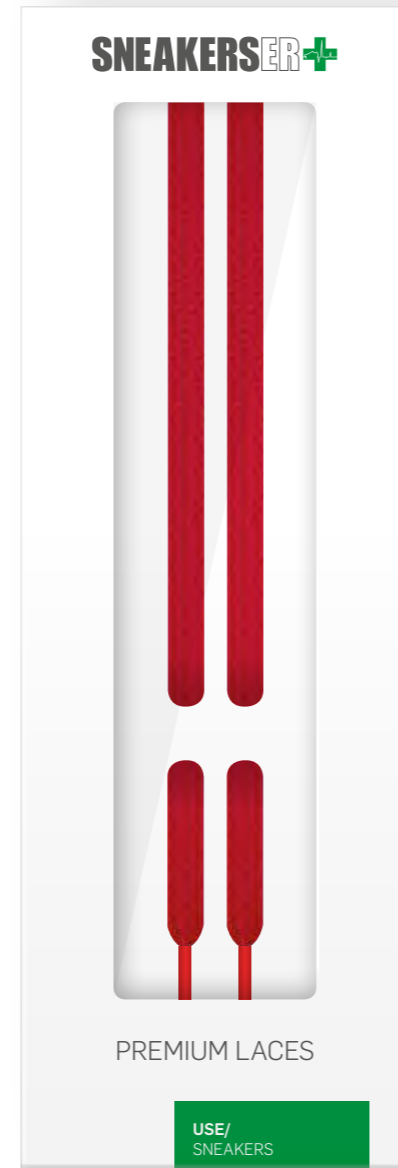



## COLLABORATIONS / PARTNERSHIPS



**SNEAKERSER+**

In partnership with:  
**new balance**

# Complimentary sneaker clean and protect

New Balance Flagship Store  
287-291 Oxford St, Mayfair,  
London W1C 2DR



To help celebrate the worldwide launch of the 990v4 model, New Balance requested SNEAKERS ER to be part of an in store activation within their U.K. flagship store on London's Oxford Street.

The activation included a complete Sneaker Laundry set up, built and installed to compliment the UK & US "Made In" retail area. Customers were able to receive "Quick Cleans" whilst taking a seat at our custom built SNEAKERS ER Cleaning Chair while also being able to leave New Balance sneakers overnight for a deeper, more thorough clean.

The prestigious activation also presented SNEAKERS ER with a perfect opportunity to launch our new range of re-branded products.



**SNEAKERS ER+**

**Oxford Street Sneaker Laundry**

27.04.18-13.05.18

New Balance Flagship Store,  
287-291 Oxford St, Mayfair,  
London W1C 2DR

Open 7 days  
from 9:30am (12pm Sunday)

Bring along your New Balance sneakers for a **FREE SNEAKERS ER+** clean and protect.

undry  
(unday)

£16.95  
£11.95  
£7.95  
£11.95  
£7.95

£16.95  
£9.95  
£7.95

SNEAKERS ER and to  
sit [www.sneakerser.com](http://www.sneakerser.com)

G A L E R I E  
*Lafayette*



# SNEAKERS ER



SNEAKERS ER was approached by New Balance France to help celebrate a distinguished GQ Footwear Event in Paris's most exclusive department store Galleries Lafayette.

Working alongside New Balance France we created a highly detailed laser etched wooden box containing a selected range of our sneaker care products. The boxes were gifted to customers instore during Paris Fashion Week.



G A L E R I E S  
*Lafayette*



[www.sneakerser.com](http://www.sneakerser.com)

adidas x SNEAKERSER+

# SNEAKERSER+

Complimentary cleaning service this Saturday from 1pm  
at the adidas flagship store, London E1.



15 Hanbury Street  
London E1.

To mark the release of the YEEZY 350 Frozen Yellow model, adidas Originals invited SNEAKERS ER to install and run two "quick clean" cleaning chairs within their flagship concept store on Hanbury Street, Shoreditch.

On release day, adidas originals customers could take advantage of complimentary cleans from our team of Sneaker Care Technicians.

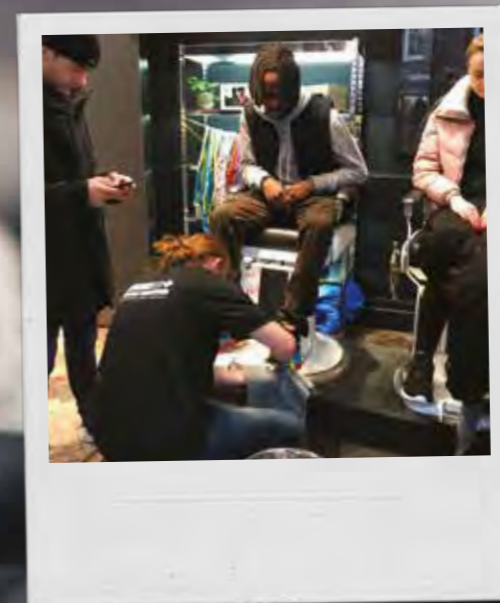
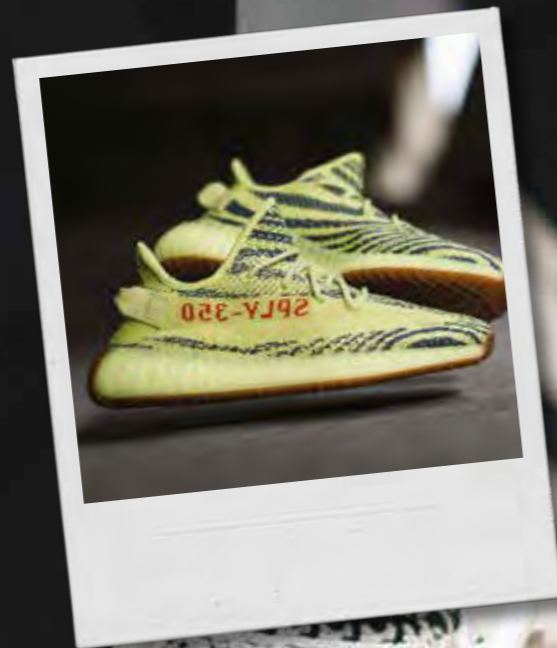



**Our collaboration with adidas at the end of 2017 was easily our highlight of the year.**

We worked alongside Chris Law at adidas' Portland HQ and after 12 months of hard work we launched the adidas 'Crafted Pack', the pack consisted of 3 adidas classic models, Gazelle, Campus and Forum Hi, each model was presented in a large, never seen before, two tier box that also included our SNEAKERS ER bespoke clean and protect kit which was a first for adidas.

For myself & Rob it was a life long dream, we were brought up with adidas and to actually get to work alongside the industry giants was the highlight of our year. From the initial chats all the way through to our time on the adidas Portland campus, it was a joy to be part of the project and to see our special packs sell all around the world in the finest sneaker boutiques was pretty special.

Each shoe was of the highest premium quality, Antelope leather supplied by Charles F Stead was used and the results were amazing, we selected the products we felt were best suited to the adidas models. Cleaner Kit was the obvious choice to keep the sneakers in prime condition but we also included our Superhydrophobic Protector Kit as the leather was unfinished and this provided a welcome barrier.

*Alan Lynn*



# CRAFTED PACK

A COLLABORATION BY  
ADIDAS ORIGINALS. SNEAKERS ER. CHARLES F STEAD.



SNEAKERS+



PRO



adidas  
ORIGINALS DRAFTED PACK

CAMPUS

FORUM HI

GAZELLE

The high-top Forum Hi basketball model is pushed to its most luxurious iteration, featuring a premium suede upper accented with a unique, adapted white stripe and white high-end laces.

The shoe's construction is the work of a master craftsman, giving an artisanal touch to the classic bold design.

The Gazelle assumes a one-piece approach in premium suede, rendered in a rich Navy Blue with gold foil details.

A contrast white tongue and laces complete the picture, placed atop a classic white midsole.



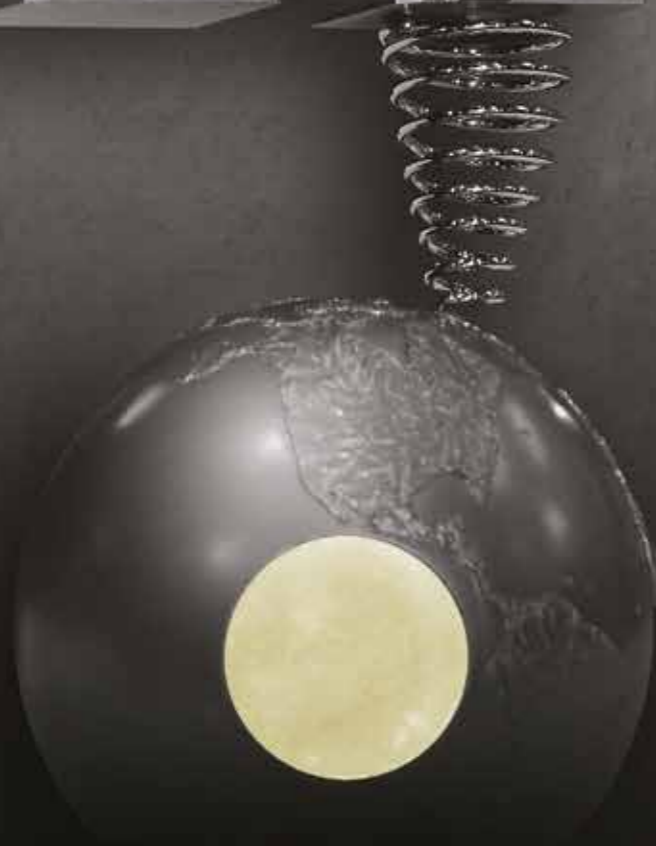

MTV, the original Music Video Station, requested that SNEAKERS ER become a part of the 2017 MTV EMA awards at the SSE Arena in Wembley, London, by gifting each artist a limited edition Sneaker Cleaning Pack.

We created a small run of 100 co-branded Cleaning Packs to be placed in each artists dressing room prior to their performance on the night.





SERCLN001  
PREMIUM SNEAKER  
CLEANING SOLUTION



SERCLN002  
PREMIUM SNEAKER  
CLEANING BRUSH



SERCLN003  
PREMIUM SNEAKER  
CLEANING CLOTH



SERCLN004  
PREMIUM CREPE  
RUBBER SUEDE BRUSH



SERCLN005  
PREMIUM SNEAKER  
CLEANING KIT



SERCLN009  
NATURAL RUBBER SUEDE  
AND NUBUCK BLOCK



SERPRT002  
SUPERHYDROPHOBIC  
SNEAKER PROTECTOR 75ml



SERMID001  
WHITE



SERMID002  
BLACK



SERMID003  
GREY



SERMID004  
OFF-WHITE



SERMID005  
GUM



SERMID006  
RED



SERMID007  
AZURE BLUE



SERMID008  
DESERT SAND



SERMID009  
LAVENDER



SERPRT005  
SUPERHYDROPHOBIC  
SNEAKER PROTECTOR 250ml



SERPRT003  
SUPERHYDROPHOBIC  
APPLICATOR BRUSH



SERPRT004  
PREMIUM SNEAKER  
PROTECTION KIT



SERPRT001  
NANO AEROSOL  
PROTECTOR



SERCRM001  
PREMIUM SNEAKER  
LEATHER REVIVING CREAM



SERWAX001  
PREMIUM SNEAKER  
DUBBIN WATERPROOF WAX



SERMID010  
MILITARY GREEN



SERMID011  
PASTEL BLUE



SERMID012  
PASTEL PINK



SERMID013  
PASTEL YELLOW



SERMID014  
PEBBLE GREY



SERMID015  
SALMON



SERMID016  
YELLOW



SERMID017  
BURGUNDY



SERMID018  
DARK GREY



SERCLN006  
6 PIECE  
TRAVEL KIT



SERCLN011  
LUXURY SNEAKER  
LEATHER DOPP KIT



SERKIT001  
CLEAN AND PROTECT SNEAKER KIT



SERKIT002  
SUEDE AND LEATHER SNEAKER KIT



SERMID019  
NAVY



SERMID020  
TAUPE



SERMID101  
INFRARED



SERMID102  
LASER BLUE



SERMID103  
CEMENT GREY



SERMID104  
INFRARED OG



SERMID105  
VARSITY



SERMID106  
ROYAL



SERMID107  
FIRE RED



SERDE001  
PREMIUM NEUTRALISING  
SNEAKER DEODORANT  
ORANGE & SANDALWOOD



SERDE002  
PREMIUM NEUTRALISING  
SNEAKER DEODORANT  
BERGAMOT & CEDARWOOD



SERDE003  
PREMIUM NEUTRALISING  
SNEAKER DEODORANT  
MEDITERRANEAN LEMON



SERMID108  
TIFFANY



SERMID109  
YEEZY MINT



SERMID110  
VOLT



SERMID201  
TURTLE DOVE



SERMID202  
PIRATE BLACK



SERMID203  
MOONROCK



SERMID204  
OXFORD TAN



SERMID301 WHITE VARSITY BLACK  
 SERMID302 WHITE ROYAL BLACK  
 SERMID303 WHITE CEMENT GREY BLACK  
 SERMID304 WHITE FIRE RED BLACK  
 SERMID305 WHITE INFRARED BLACK  
 SERMID306 WHITE INFRARED OG BLACK



SERMID401 WHITE  
 SERMID402 BLACK  
 SERMID404 OFF-WHITE



SERDGR001 PREMIUM SNEAKER PAINT PREPARATION 125ml  
 SERDGR002 PREMIUM SNEAKER PAINT PREPARATION 250ml  
 SERSLB001 PREMIUM SNEAKER RESTORATION GLUE 125ml  
 SERSLB002 PREMIUM SNEAKER RESTORATION GLUE 250ml



SERACR001 WHITE  
 SERACR002 BLACK  
 SERACR003 BLUE  
 SERACR004 GREY  
 SERACR005 GREEN  
 SERACR006 LIGHT BLUE  
 SERACR007 LIGHT GREEN  
 SERACR008 LIGHT GREY  
 SERACR009 ORANGE



SERACR010 PINK  
 SERACR011 PURPLE  
 SERACR012 RED  
 SERACR013 TURQUOISE  
 SERACR014 YELLOW



SERANG001 GAZELLE RED  
 SERANG002 GAZELLE BLUE  
 SERANG003 GAZELLE PURPLE  
 SERANG004 GAZELLE PINK  
 SERANG005 GAZELLE GREEN  
 SERANG006 BRUSSEL BLACK  
 SERANG007 LONDON RED  
 SERANG008 STOCKHOLM BLUE  
 SERANG009 MALMO YELLOW



SERANG010 DUBLIN BLUE  
 SERANG011 ARGY BLUE  
 SERANG012 ARDWICK  
 SERANG013 TOPANGA BROWN  
 SERANG014 TOBACCO BROWN  
 SERANG015 TOBACCO DARK BROWN  
 SERANG016 TEAL  
 SERANG017 CLARET  
 SERANG018 COLOURLESS FOR MIXING



SERODR001 UK6    SERODR002 UK7    SERODR003 UK8    SERODR004 UK9    SERODR005 UK10    SERODR006 UK11    SERODR007 UK12    SERODR008 UK13



SERLCS001 WHITE    SERLCS002 BLACK    SERLCS003 RED    SERLCS004 NAVY    SERLCS005 LIGHT GREY    SERLCS006 DARK GREY    SERLCS007 NATURAL    SERLCS008 TAUPE    SERLCS009 BROWN



SERLCS010 DARK BROWN





**SNEAKERSER**   
KNOWLEDGE BEHIND EVERY PRODUCT

**Store / Sneaker Laundry:** 11 Royal Exchange Square, Glasgow, G1 3AH. / Tel: +44 (0) 141 465 1372

**Office / Distribution / Showroom / Demo Centre:** Rogart Street Campus, 4 Rogart Street, Glasgow, G40 2AA. / Tel: +44 (0) 141 572 5073

**Warehouse:** 141 Broad Street, Unit 2, Glasgow G40 2QR. / Tel: +44 (0) 141 237 9330

[www.sneakerser.com](http://www.sneakerser.com)